

Accuracy and tracking performance extremely improved

Radar Level Transmitter

Version
upgrade

MWLM-PR26 Series

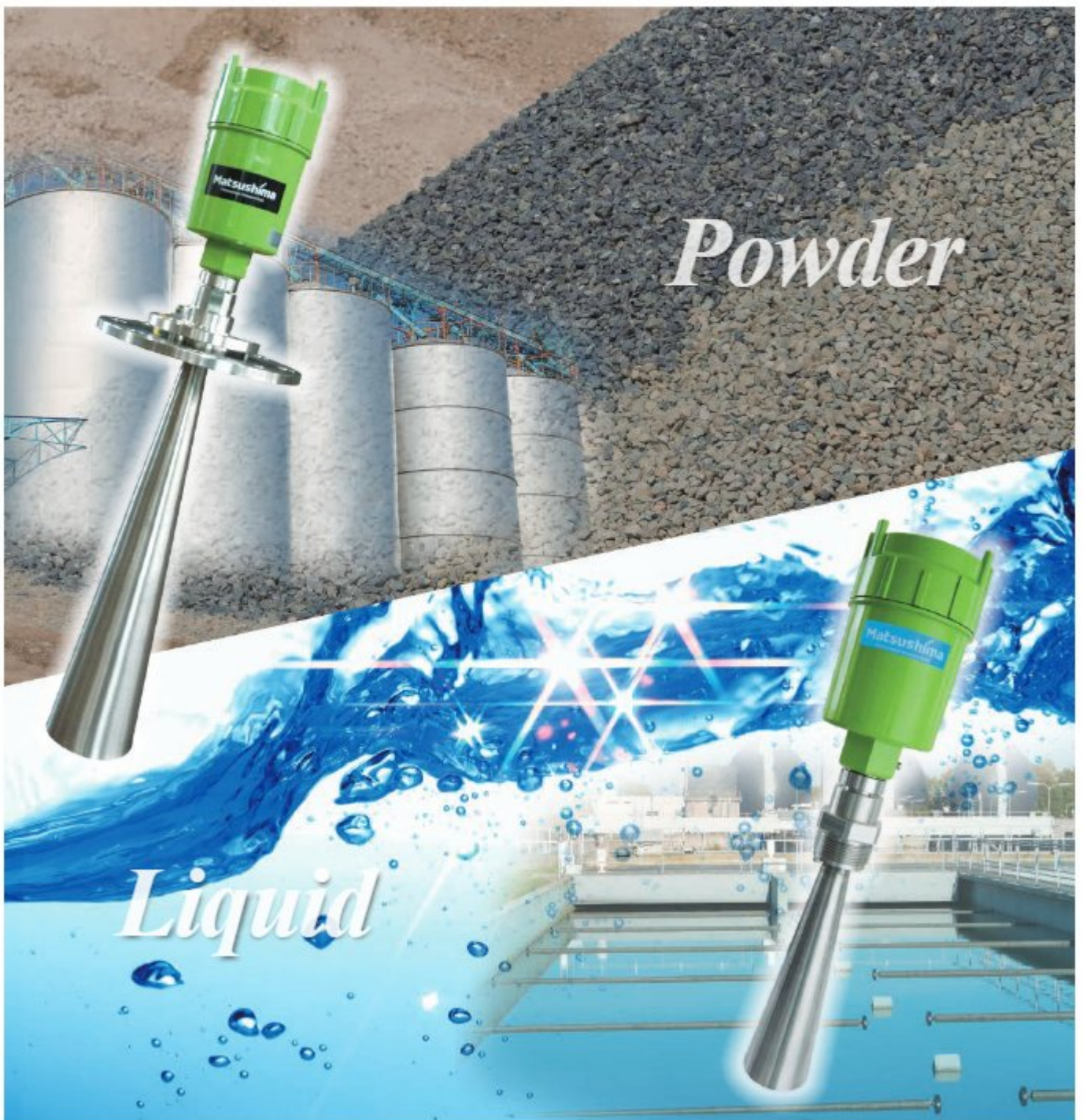

Extended the product warranty

Matsushima's radar level transmitter is manufactured domestically from software to hardware, so it can be delivered quickly with stable supply, and also support our customers with quick maintenance. Since Matsushima has 60 years of experience in measurement control, we are able to meet our customer's requests regarding installation to the facilities.

Customization

Customize the level meter for suitable measuring environments and usage. Able to provide customized level meter in applications that have restrictions under high temperature and high pressure areas.

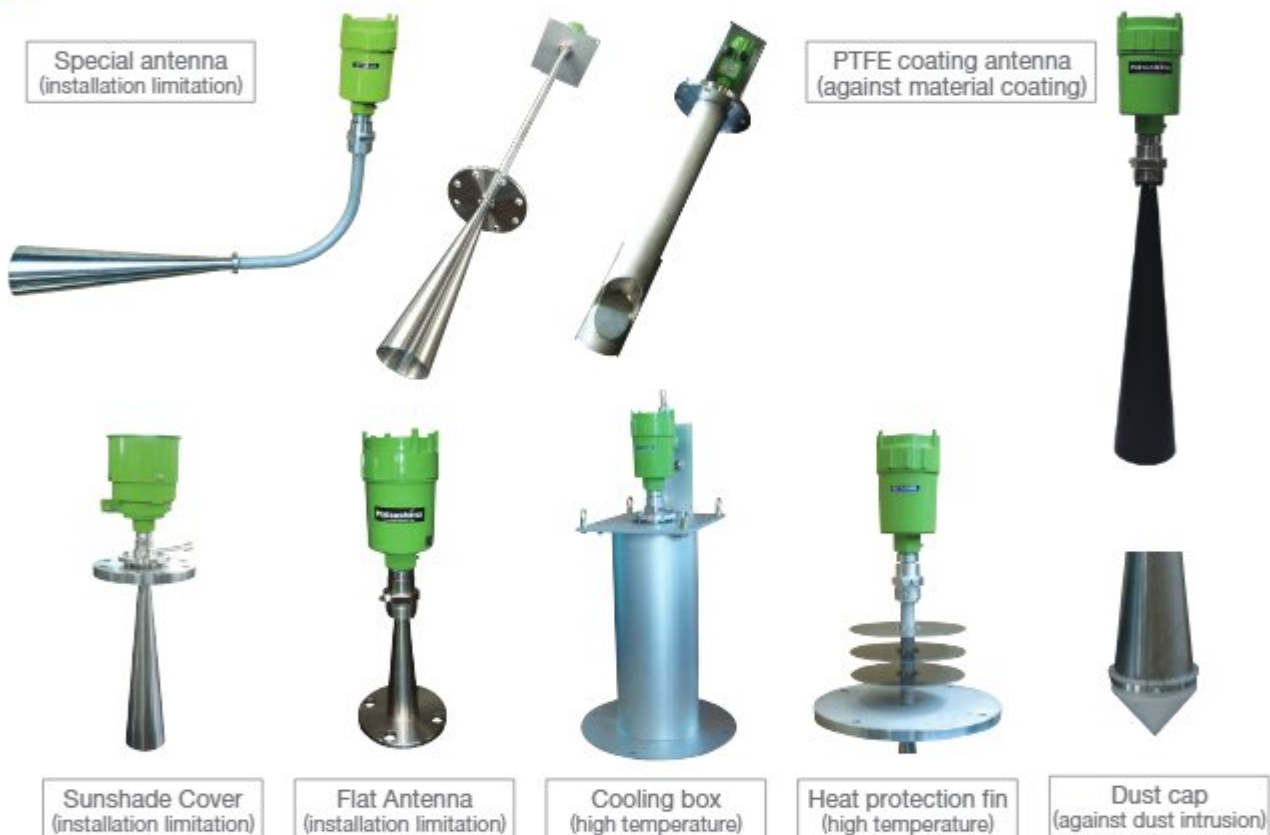

Measuring Principle

The microwave level meter measures the time from when the level meter emits pulse radar waves from the antenna to when the waves (echoes) reflected from the object to be measured return to the meter, which is then calculated into a distance.

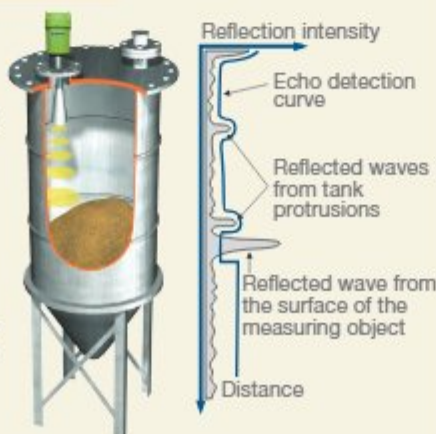

Explosion-proof type

Intrinsically safe construction Ex ia II B T4 X (TIS)

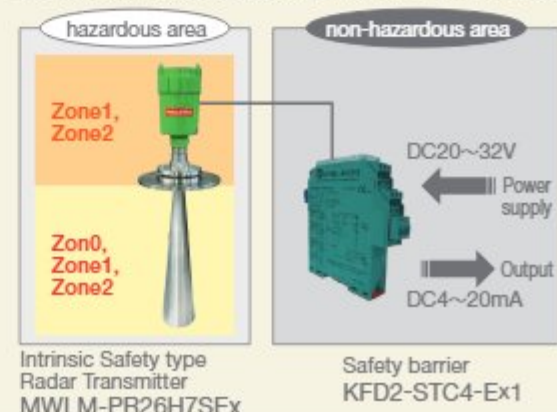

*Remark: MWLM-PR26C1G cannot be applied in Zone0.

Warranty period to 2 years.

Flexible
customization
capability

Applications

Applies to a variety of applications and flexible customization capability based on our long experience and know-how.

Usage in Applications

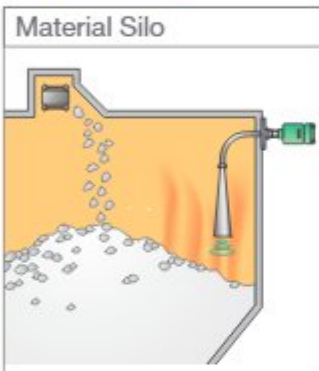

Material Silo

If there's no space to install on top of the silo, it is able to measure from the side of the silo.

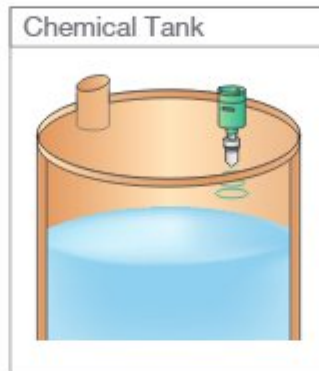

Chemical Tank

By attaching the PTFE antenna, it is able to measure corrosive chemicals.

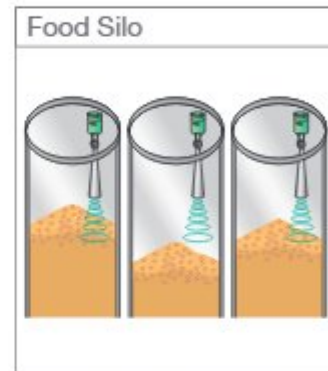

Food Silo

Narrow beam angle allows to measure inside a thin, long grain silos.

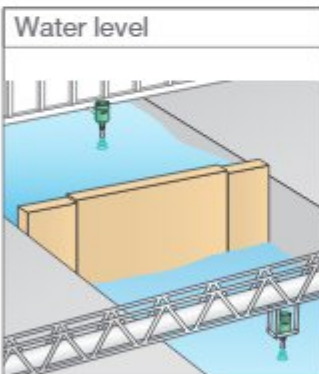

Water level

Able to continuously measure without being affected by rain, wind, and snow.

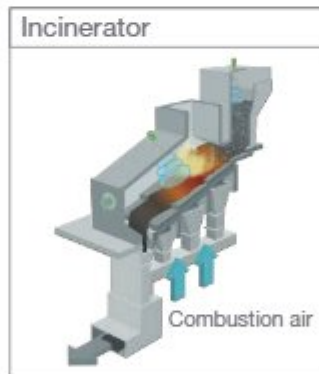

Incinerator

Even if antenna is not allowed to be put inside, it can be measured by flat antenna type.

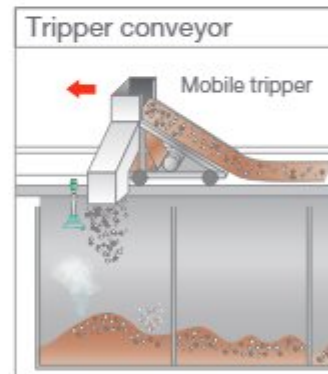

Tripper conveyor

It can follow a sudden level change in bunker. Dust and vapor do not influence level measurement.

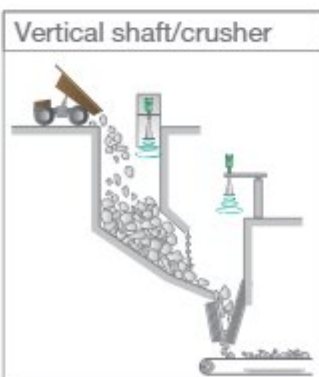

Vertical shaft/crusher

It is suitable for vertical shaft or crusher due to high tracking-speed performance.

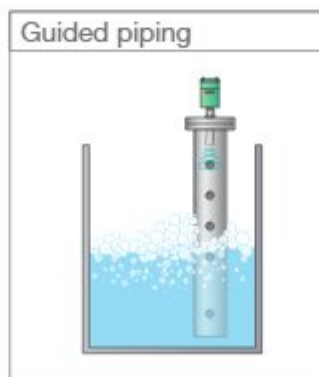

Guided piping

The liquid level can be measured without foam intrusion into piping.



Material to be easily built up

PTFE coating antenna prevents the material from being built up on the antenna, and results in stable level measurement.

Well experienced in Application Supports

Displays with 4 languages Outstanding operation

Easy Operation

Simple and precise operation possible. Site maintenance with simple hand communicator "GRAPHIC COM4". Remote operation with customer friendly software.

Local Operation

"GRAPHIC COM4", a detachable LCD adjuster, has a liquid crystal display with high-visibility. You can see waveforms in real time while monitoring, and you can adjust settings if needed.



GRAPHIC COM4 on the sensor head

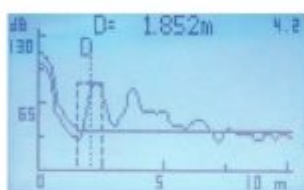

Real time indication for measurement situation

Remote Operation

The PC with adjustment software allows easy operation for complex parameter settings.

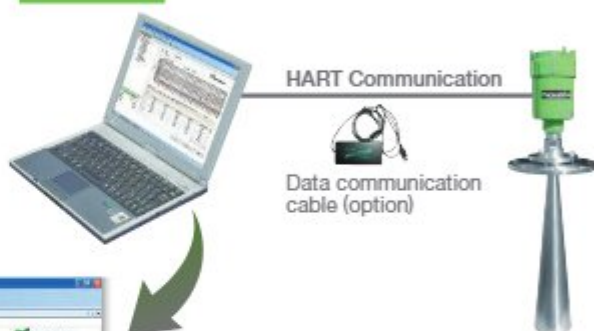

Software Features

- Real time indication for measurement situation
- Make adjustment
- Check waveforms while monitoring and store the data
- Record trends
- Languages: Japanese, English, Chinese, and Korean



High measuring performance under any conditions

① Improved accuracy

Double measuring accuracy!

Model	Before	New version
For powder H7, H3	±50mm	≤1.2m : ±20mm >1.2m : ±10mm
For liquid H2, H1, C1	±50mm	≤1.2m : ±30mm >1.2m : ±20mm

② Improved tracking speed

Faster response time & better tracking performance than Ultrasonic sensor

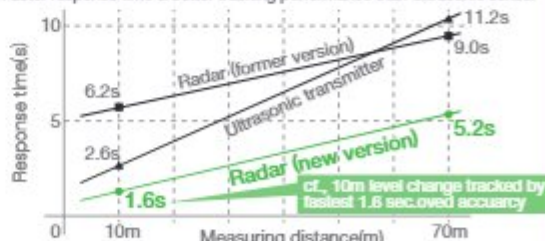

*Response time depends on measuring distance & adjustments

③ Expanded allowable power supply

Reliable under unstable power circumstances where voltage fluctuates

LCD display	Before	New version
No LCD	DC20~32V	DC13~36V
With LCD	DC20~32V	DC16~36V

Remark: 20 ~32V for Ex-proof type

④ Wiring distance increased

Load resistance has improved from 499Ω to 655Ω!!
Max. wiring distance extended.

	Before	New version
Max. wiring distance	4.5km	7.5km

Conditions: Power supply DC24V, Load resistance 250Ω, Cable (AWG#18, dia.0.75mmf, Load resistance 26Ω/km)

For Liquid		Specifications			
Model	MWLM-PR26C*	MWLM-PR26H*		MWLM-PR26H2F*	
Product Code	MWLM-PR26C1G*	MWLM-PR26H1G	MWLM-PR26H2G*	MWLM-PR26H2F*	
Antenna	Cone		Horn		
Power Supply	Standard: DC13 - 36V #1 DC16V or more is required for LCD unit. Ex-proof: DC20 - 32V#2 Power supplied by safety barrier KFD2-STC4-Ex1				
Power Consumption	Standard type: Approx. 704mW, Explosion-proof: Approx. 540mW				
Mounting	G2 Thread	G1 Thread	G1 1/2 Thread	JISSK50A Flange	
Dead Zone	0.5m (1.64ft) below the antenna				
Max Measurable Distance	10.0 (33ft) from measuring reference zero point		20.0 (66ft) from measuring reference zero point		
Transmitting Frequency	Approx. 26GHz				
Transmitting Cycle	Every 83ms				
Beam Angle	Approx. 24 (approx. 48deg. including side beam)		Approx. 18 (approx. 36deg. including side beam)		
Resolution	1mm				
Allowable Fluctuation Rate	10cm/s				
Accuracy	Repeatability	Within 1.2m (3.94ft) or less: ±30mm (1.18in), Over 1.2m (3.94ft) or more: ±20mm (0.78in) or ±0.04% of measurement range (Whichever is greater)			
	Temp. Error	Standard: ±0.03 /10K, Ex-proof: 0.06%/6K			
Ambient Temperature	Housing	Standard: -40 +80 (-40 +176), With LCD: -20 +60 (-4 +140), Ex-proof: -20 +50 (-4 +122) 1 hour is required to warm up the device if the temperature is lower than -20 (-4).			
	Antenna	Standard: -40 +150 (-40 +302), Ex-proof: -40 +100 (-40 +212)			
Allowable Pressure	500kPa		1MPa		490kPa
Material	Housing	ADC			
	Antenna	PTFE		SUS316L	
Protection	IP67 (Housing cover and lead outlet must be closed)				
Lead Outlet	1-G1/2 (Applicable cable size: #8 to 12mm (0.31 to 0.47in))				
Output Signal	DC4 20mA × 1 (Load resistance when 24VDC power supply is used: 499 Ω max), HART communication				
Integral Time	0 999s				
Mass	Approx. 1.9kg		Approx. 1.6kg		Approx. 1.9kg
Explosion-proof construction	Intrinsically safe construction Ex ia B T4 X (TIIS)		Intrinsically safe construction Ex ia B T4 X (TIIS)		
	Zone1, Zone2		Zone1, Zone2		
Division of hazardous section	Housing	Zone1, Zone2		Zone0, Zone1, Zone2	
	Antenna	Zone1, Zone2		Zone0, Zone1, Zone2	
Accessories (option)	LCD adjustment unit (GRAPHIC COM4) Data Communication cable (MHM-01) PC adjustment software (M-DTM) Safety barrier (KFD2-STC4-Ex1) is needed to use the explosion proof type. LCD display can't be used since it's a non explosion proof parts.				

*: Explosion Proof model has Ex written at the end of each model. Explosion proof structure is Ex ia B T4 (TIIS).

●Dimension mm [in]

Model : MWLM-PR26□□□□

C1G

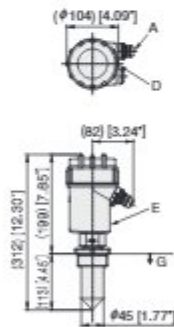

H1G

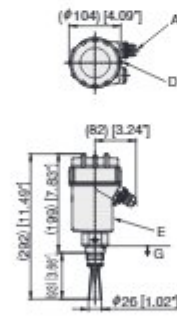

H2G

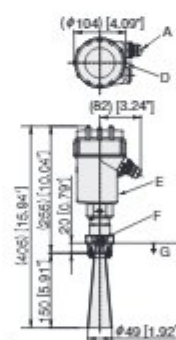

H2F

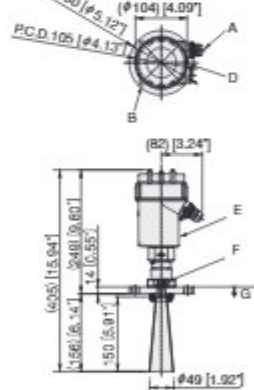

A	Lead outlet: G1/2	Cable: φ8-12mm [0.31-0.47"]
B	4xφ15 [0.59"] Mounting hole	
C	8xφ19 [0.75"] Mounting hole	
D	Earth terminal (M4)	Be sure to ground the earth terminal. (D-class grounding)
E	Housing	Housing rotatable in 310°.
F	Purge nozzle: Rc1/8	
G	Measurement reference zero point	

Common for Liquid & Powder	Terminal Block	Specs & Dimensions of the safety barrier
<p>* : Two wire shielded cable is recommended. For explosion-proof type, provide the power through the Safety Barrier.</p>		<p>Specifications</p> <p>Power Specs.</p> <ul style="list-style-type: none"> Power Supply: DC20 ~ 35V Power Consumption: 1.9kW <p>Input Specs.</p> <ul style="list-style-type: none"> Input Signal: 0/4 ~ 20mA Available voltage: ≥16V at 20mA terminal 1+,3 <p>Output Specs. (Safety area)</p> <ul style="list-style-type: none"> Output signal: 0/4~20mA ; load 0~500Ω Pulsating Current: ≤50μA rms Mass: 200g (0.44lbs)

*This product uses a connection to the distributor or isolated interface(HART supported) and a card as a basic connection. For other connection methods and for any questions, please contact us.

For Powder		Specifications					
Model	MWLM-PR26H*						
Product Code	MWLM-PR26H3G*	MWLM-PR26H3F*	MWLM-PR26H3S*	MWLM-PR26H7G*	MWLM-PR26H7F*	MWLM-PR26H7S*	
Antenna	Horn						
Power Supply	Standard: DC13 - 36V *1 DC16V or more is required for LCD unit. Ex-proof: DC20 - 32V*2 Power supplied by safety barrier KFD2-STC4-Ex1						
Power Consumption	Standard type: Approx.704mW, Explosion-proof: Approx.540mW						
Mounting	G1 1/2 Thread	JIS5K65A Flange	Swiveling Flange (Equivalent to JIS10K100A)	G1 1/2 Thread	Equivalent to JIS10K100A	Swiveling Flange (Equivalent to JIS10K100A)	
Dead Zone	0.3m (0.98ft) below the antenna						
Max Measurable Distance	35.0m (115ft) from measuring reference zero point			70.0 m (330ft) from measuring reference zero point			
Transmitting Frequency	Approx. 26GHz						
Transmitting Cycle	Every 83ms						
Beam Angle	Approx. 14deg. (approx. 28deg. including side beam)			Approx. 8deg. (approx. 16deg. including side beam)			
Resolution	1mm						
Allowable Fluctuation Rate	10cm/s						
Accuracy	Repeatability	Within 1.2m (3.94ft) or less: ±30mm (1.18in), Over 1.2m (3.94ft) or more: ±20mm (0.78in) or ±0.04% of measurement range (Whichever is greater)					
	Temp. Error	Standard: ±0.03%/10K, Ex-proof: 0.06%/6K					
Ambient Temperature	Housing	Standard: -40 ~ +80°C (-40 ~ +176°F), With LCD: -20 ~ +60°C (-4 ~ +140°F), Ex-proof: -20 ~ +50°C (-4 ~ +122°F) 1 hour is required to warm up the device if the temperature is lower than -20°C (-4°F).					
	Antenna	Standard: -40 ~ +150°C (-40 ~ +302°F), Ex-proof: -40 ~ +100°C (-40 ~ +212°F)					
Allowable Pressure	Housing	1MPa	490kPa	500kPa	1MPa	250kPa	
	Antenna	500kPa					
Material	ADC SUS316L						
Protection	IP67 (Housing cover and lead outlet must be closed)						
Lead Outlet	1-G1/2 (Applicable cable size: φ8 to 12mm (0.31 to 0.47in))						
Output Signal	DC4 ~ 20mA × 1 (Load resistance when 24VDC power supply is used: 499 Ω max), HART communication						
Integral Time	0 ~ 999s						
Mass	Approx. 2.3kg	Approx. 4.4kg	Approx. 6.1kg	Approx. 2.7kg	Approx. 5.3kg	Approx. 6.5kg	
Explosion-proof construction	Intrinsically safe construction Ex ia IIB T4 X (TIIS)						
Division of hazardous section	Housing	Zone1, Zone2					
	Antenna	Zone0, Zone1, Zone2					
Accessories (option)	· LCD adjustment unit (GRAPHIC COM4) · Data Communication cable (MHM-01) · PC adjustment software (M-DTM) Safety barrier (KFD2-STC4-Ex1) is needed to use the explosion proof type. LCD display can't be used since it's a non explosion proof parts.						

*: Explosion Proof model has Ex written at the end of each model. Explosion proof structure is Ex ia IIB T4 X (TIIS).

●Dimension mm [in]

Model : MWLM-PR26 □□□

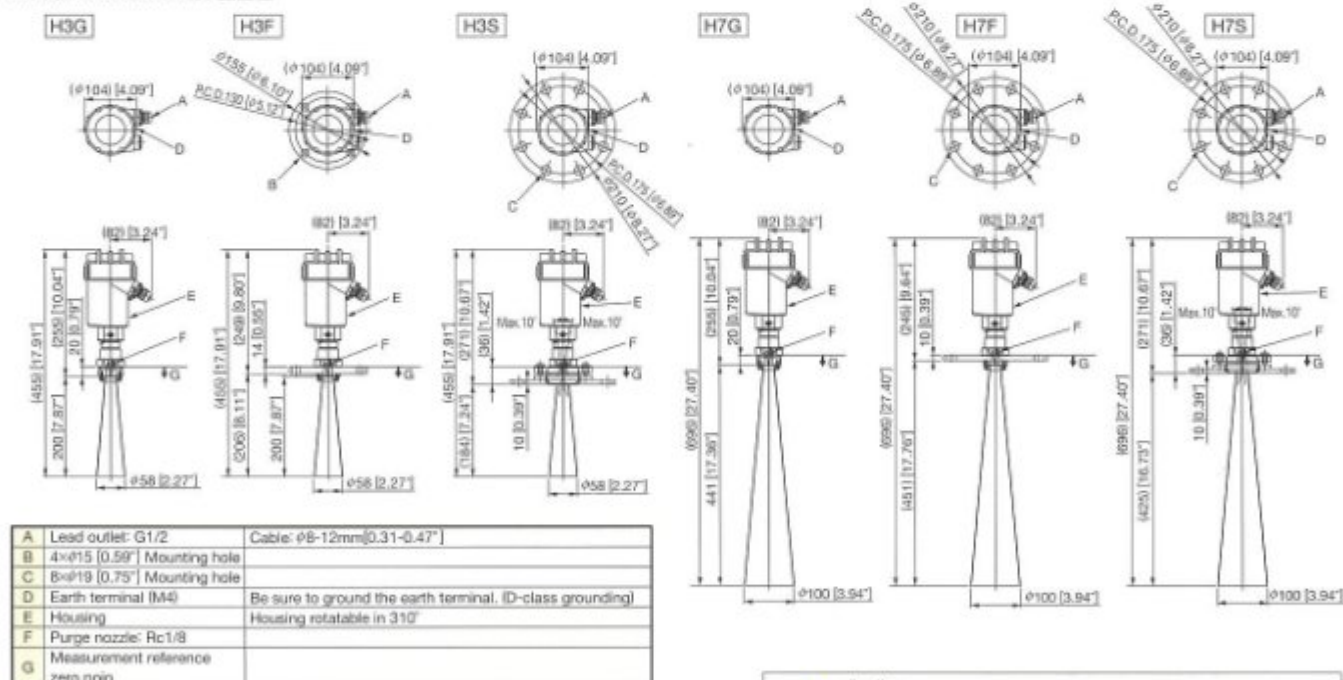

Specifications are subject to change without notice.
All Rights Reserved Copyright ©2020, Matsushima Measure Tech Co., Ltd.



Caution
●Read the instructions to ensure correct and suitable application of products.
●Contact our nearest sales office when using our products for any systems used in situations which may be life threatening.

Distributor



ISO9001 ISO14001

本社 (HEAD OFFICE)

Matsushima Measure Tech Co., Ltd.

HEAD SALES OFFICE / FACTORY
1-8-18, Norimatuigashi, Yahatanishi-ku, Kitakyushu,
807-0837, Japan
Tel: +81-093-691-3731 Fax: +81-093-691-3735

SHANGHAI DAHONG MATSUSHIMA MACHINERY CO., LTD.
70 Hengchang Road, Dahong, Malu, Jiading,
Shanghai 201801, China
Tel: +86-021-59514138 Fax: +86-021-59514139

Seoul Liaison Office (Korea)
220, 2F Hyundai Knowledge Industry Center, 70, Dusan-ro,
Geumcheon-gu, Seoul, Republic of Korea 08584
Tel: +82-02-852-3731 Fax: +82-02-852-3734

<https://www.matsushima-m-tech.com> E-mail: info@matsushima-m-tech.com