



ITmedia Inc.



Webcast Service Guide

August 2021 edition

ITmedia's Webcasts

ITmedia has more than 1,500 experiences in web seminar promotion, not only in distribution, but also in planning, customer attraction and combined promotion with media.

Point 1

Integrated support from planning to reporting

Organizing an event requires a full range of resources, from planning to reporting. ITmedia provides consistent support from planning, announcements, audience creation, seminar management and event reports. Based on our extensive experience, we will contribute to the success of your event and your company's performance.

Point 2

Highly effective in reducing operating costs and improving efficiency

The greatest merit of online events is that they can be held 24 hours a day, from any location, and without the need to visit a venue. Because the content of the actual event (physical event) can be provided online, such as the lecture videos and the distribution of materials, the costs associated with exhibiting, preparation time and labor costs can be reduced.

Point 3

Real-time analysis of viewing status is possible

It is equipped with online reports that allow you to check users' viewing and action history in real time.

It also has a questionnaire and inquiry function that allows event organizers and users to communicate, so it can be used not only to follow up on events, but also as a tool for acquiring and analyzing lists of potential customers.

ITmedia has supported more than 1,500 webcast deliveries, ranging from large seminars with more than 1,000 viewers to small seminars for dozens of viewers.

ITmedia has experiences in holding webcasts in a wide range of industries and business applications, including the IT, pharmaceutical and manufacturing industries

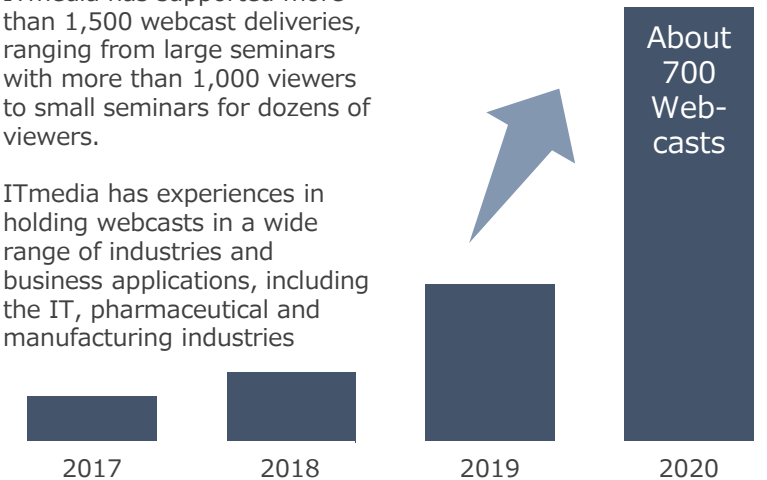

Examples of companies we have done business with

abbvie

KDDI

salesforce

SB C&S

DELL

Hewlett Packard Enterprise

Plan List

Plan name	Outline	Planning support	Audience creation support	Webcast delivery support	Details
Full Support Plan	<p>ITmedia editorial team, which understands readers and the market, and our webcast delivery team, which has a wealth of experience, will fully support the success of your webcast.</p> <p>ITmedia's editorial department, which has a deep understanding of market trends and reader needs, will plan a webcast program/lecture to deliver an accurate message to your target audience, and a specialized team will be in charge of announcing and attracting audience, mainly ITmedia readers, as well as the operation bureau and delivery of the webcast.</p> <p>This plan provides one-stop support and services for a complete webcast.</p>	✓	✓ Guaranteed number of audience (Live/Simulive + On-demand)	✓	Page 3
Webcast Delivery and Audience Creation Support Plan	<p>Support for webcast delivery hosted by your company and audience creation.</p> <p>This is a package plan that supports the delivery of your webcast and attracts audience (with performance-based charges based on the number of registrants).</p>	-	✓ Results-based charge	✓	Page 5
Webcast Delivery Support Plan	<p>Support for webcast delivery hosted by your company.</p> <p>This is a plan to support the delivery of your company's webcasts. Our staffs, who have rich experience in delivering webcasts, will provide support so that you can conduct your webcasts without worry.</p>	-	-	✓	Page 6

Full Support Plan

Full support for the success of your webcast by ITmedia editorial team, which understands readers and markets, and our webcast delivery team, which has a wealth of experience.

ITmedia's editorial department, which has a deep understanding of market trends and reader needs, will plan a webcast program/lecture to deliver an accurate message to your target audience, and webcast delivery team will be in charge of announcing and attracting audience, mainly ITmedia readers, as well as the operation bureau and delivery of the webcast. This plan offers one-stop support and provision of a complete webcast package.

Planning

ITmedia will have a meeting with you in advance to propose a seminar title, program and guest session plan that suit the purpose and target of your webcast. After the content is decided, we can also handle guest speaker assignments, meetings and various adjustments.



Audience creation

ITmedia will create the necessary announcement and a registration page to attract audience, and will use ITmedia's email newsletters to attract readers.



Shooting and delivery

In addition to handling registrants up to the event, the bureau will handle preparations such as collecting presentation materials from speakers and preparing scripts of sessions and interludes. ITmedia will also support lectures with our partner companies on the day of the delivery.



Follow-up

We will provide reports for follow-up after the event, as well as review meetings as needed.

If you wish to use on-demand webcast, we can also configure its settings.



In the case of media-sponsored seminars, ITmedia basically cannot refuse audience to register. Please allow all participants to attend the webcast regardless of whether or not they are eligible to be charged under audience creation support.

Please specify up to 10 companies (groups are not allowed) for competitor exclusion. Domain exclusion by the system is also possible. However, even if these companies/domains are provided in advance, they will not be refused to attend the webcast. (But they will not be subject to charges for audience creation support.)

Content and Price of Full Support Plan

Package price

Half Day Plan* JPY 2,000,000 or more (tax not included, gross)

*4 hours (Setup and rehearsal: 2 hours/ Live webcast: 90 min / Withdrawal: 30 min)

Full Day Plan JPY 2,500,000 or more (tax not included, gross)

What's included in the package price

Planning	Planning, guest assignment or moderation by editorial person
Audience creation	Guaranteed total number of registration (including On-demand)
Operation	Registration page creation and webcast delivery
Professional equipment	Camera and switcher
Support	Support for registrants and operational instruction
On-demand	2 months with up to 500 registrants (As a total of Live/Simu-Live)

*For more details of specifications, please see the page 17.

Half Day Plan example and its time table

Plan	Program structure	Time (approx.)
A	Keynote speech	30 to 45 minutes
	Sponsor session	20 to 40 minutes
B	Keynote speech	30 minutes.
	Sponsor session	15 minutes.
C	Panel discussion	45 minutes.
	Keynote speech	30 minutes.
	Panel discussion	50 to 60 minutes

- Basically, the live time is assumed to be **within 90 minutes for the Half Day Plan**. If you want to extend the delivery time, additional fee (JPY 30,000 / 30 min) will be charged.
- If you need more than 4 hours from preparation and rehearsal to the withdrawal, please choose the Full Day Plan.
- If you want special requests other than the basic specifications (page 17), please contact our salesperson. Additional fee may be needed.
- Additional planning fees will be charged depending on the content of the project, such as assigning 2 or more lecturers or designating a lecturer with a high speaking fee.
- The expected number of registration depends on the webcast content or topic, so please contact with us in advance.
- In case the number of registration is short against the guaranteed number, ITmedia will offer the relocation to a lead generation service.
- Up to 10 competitor exclusion is available in the Full Support Plan.

Webcast Delivery and Audience Creation Support Plan

Support for webcast delivery hosted by your company and audience creation

This is a package plan that supports the delivery of your webcast and audience creation (with performance-based charge based on the number of registrants).

Audience creation

ITmedia will create the necessary announcement and a registration page to attract audience, and will use ITmedia's email newsletters to attract readers.



Registration page

Shooting and delivery

Providing the delivery platform and also ITmedia expert staffs with a wealth of experience will support the delivery of your webcast.

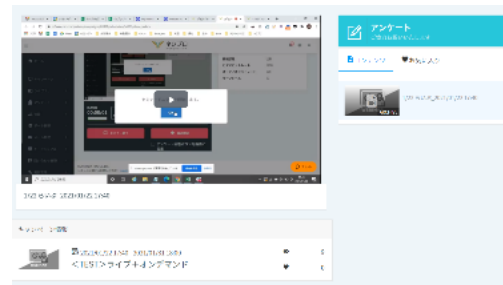

Webcast delivery / delivery support

Price

Webcast Delivery and Audience Creation Support Plan

JPY 1,000,000 or more

Audience Creation Support

No target audience specified: JPY 15,000/person
(Early bird discount applied: JPY 13,000/person)
User company specified: JPY 30,000/person
(Early bird discount applied: JPY 26,000/person)

Early bird discount is available only when the application and submission of the requirement sheet are completed at least 40 business days in advance.

Delivery Support

Half Day Plan: JPY 500,000
Professional equipment usage fee: JPY 300,000 or more

Example of package plan

Audience Creation Support

No target audience specified: Maximum of 50 applicants

Delivery Support

Half Day Plan and no professional equipment

Package price

JPY 1,250,000 (If the number of applicants is less than 50, the shortage will be deducted at JPY 15,000/person)

- ※ITmedia will offer an individual package according to your budget and requirements.
- ※For details on specifications, options and precautions, please refer to the documents "Web Seminar Service Webcast Delivery Support Plan" and "Pay-for-Performance Audience Creation Service".
- ※Up to 10 competitor exclusion is available.

Webcast Delivery Support Plan

Support for webcast delivery hosted by your company

This plan supports the distribution of your company's webcasts. Our staff, who have a wealth of experience in delivering webcasts, will provide support so that you can conduct your webcasts without worry.

Staffs and equipment composition (without professional equipment)

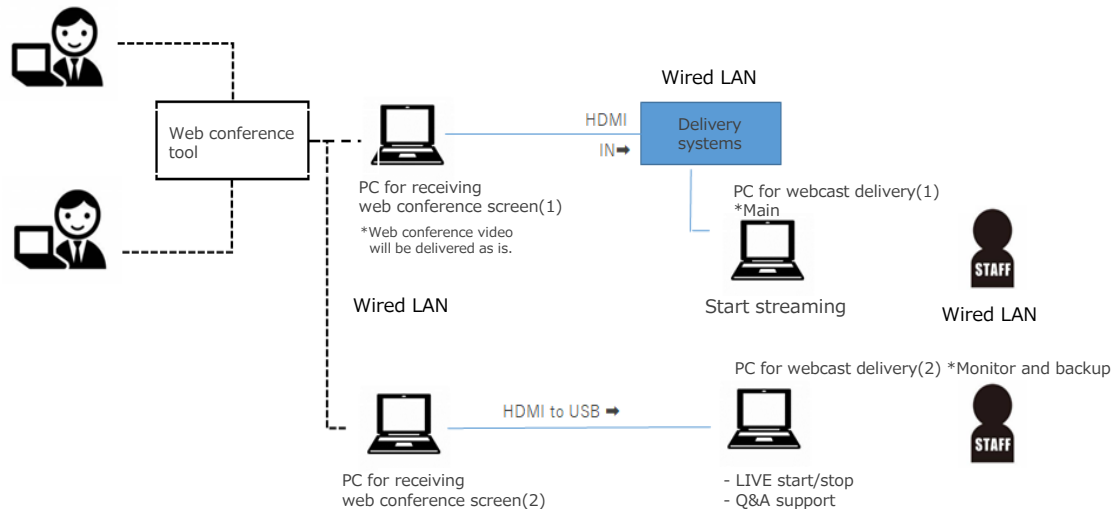

- The lecturer's PCs will be connected to the web conference tool.
- The camera and microphone will be used on the PCs.

* If you do not specify a web conference tool, we will prepare a ZOOM meeting.

Price per session	Number of registrants (Up to 500)	Professional equipment usage fee
Half Day Plan	JPY 500,000	JPY 300,000 or more

The basic delivery time is assumed to be **within 90 minutes for the Half Day Plan**. If you want to extend the delivery time, additional fee (JPY 30,000 per 30 minutes) will be charged. If it takes more than 4 hours from preparation and rehearsal to the end of delivery and withdrawal, please order the delivery operation extension option.

The professional equipment usage fee includes 2 cameras, audio equipment, switcher, and camera crews and switching staff are included. For details on equipment configuration, please refer to page 17-19.

The webcast will be available with on-demand for 2 months. It will start 2 days after the webcast delivery. Please note that the webcast data will be deleted after 2 months.

If the number of registrants exceeds 500, an additional fee (JPY 50,000 for every 250 registrations) will be charged.

Examples of Webcast Delivery Support Plan Optional Service

Content	Price	
<p>Additional registrant fee</p> <p>The maximum number of registered users in the basic plan is 500.</p>	Every additional 250 people	JPY 50,000
<p>Webcast delivery time extension</p> <p>The delivery time in the basic plan is 90 minutes.</p>	Every additional 30 minutes	JPY 30,000
Operation fee for extended webcast delivery time (all day)	Up to 8 hours total	+JPY 300,000
Professional equipment usage fee for extended webcast delivery time (all day)	Up to 8 hours total	Separate Quote
Rehearsal on a different day from the live streaming Day/pre-recording day, and additional shooting	1 time	JPY 100,000 or more
<p>Video editing</p> <p>Cut unnecessary parts of the recorded video, adjust audio, etc.</p>	1 session	JPY 50,000 or more
<p>Webcast shooting and delivery at studios other than ITmedia office (external studio and equipment fees)</p> <p>In addition to the studio fee (actual cost), a venue adjustment and management fee will be charged.</p>	1 time	Actual cost + Management fee
Extend on-demand webcast period	every 1 month	JPY 30,000
Additional cost for issuing report account/speaker account	Every 2 months	JPY 20,000 per person

Sample Schedule (Webcast Delivery and Audience Creation Support Plan)

The actual delivery schedule will be provided after you provide the application form. For details, please contact your sales representative. Please apply at least 2 months prior to the desired delivery date when you want to order the Full Support Plan.

Live streaming

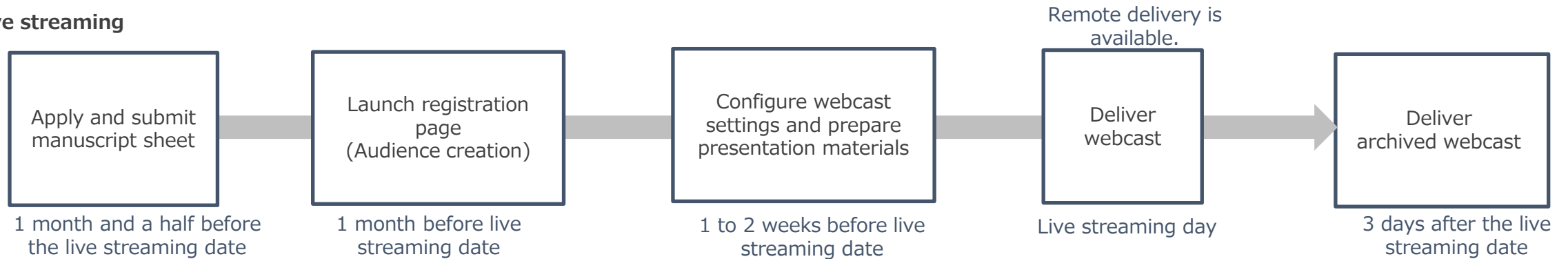

Simu-Live streaming (Pseudo-live streaming)

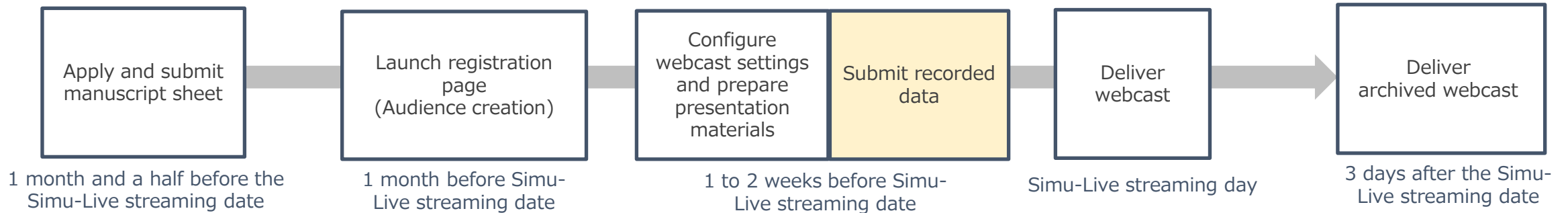

※If you apply or submit the manuscript sheet quickly, the registration page can be launched quickly. Customer list importing is also available ※JPY 30,000/import (tax not included)

※The archived webcast can be delivered 1 day after the live streaming date.

Note

For Simu-Live streaming, the recorded data is necessary to be submitted at least 1 week before the streaming day. In the case of cancellation, a cancellation fee will be charged.

Frequently Asked Questions

- **I'd like to know the approximate schedule until the delivery date.**
 - Please submit the application form and manuscript sheet 45 days (1.5 months) prior to the scheduled delivery date.
 - Please apply for the Full Support Plan at least 60 days (2 months) prior to the desired delivery date, taking into account the time required to discuss the content of the plan and assign lecturers.
 - It is common to publish a registration page 30 days before the delivery date.
 - Please submit your video for Simu-Live (Pseudo-Live) at least 14 days (2 weeks) before the delivery date.
 - See page 8 for details.
- **Which do you recommend, Live Streaming or Simu-Live Streaming?**
 - There is no particular difference in the participation rate. (Simu-Live delivery is delivered as if it were being done on Live, so viewers have a sense of the premiere of the event, and the dropout rate is low).
 - If it is difficult to coordinate the schedule of the speakers on the day of the event, many customers choose Simu-Live delivery.
 - Since pre-recording take a long time to record because it can be reshot when it fails., many customers use Live Streaming.
- **Can you make a pre-recorded video for me?**
 - We can offer this service for an additional fee. (Please contact us for more details.)
- **Is it possible to register viewers for a seminar based on the customer data (email address) that we currently have?**
 - List importing is available. (JPY 30,000 per import)
- **Where are the servers for the delivery platform located?**
 - Servers are located in Japan.
- **Is the delivery platform certified for security?**
 - Yes. Certification for JIS Q 27001:2014 (ISO/IEC 27001:2013), the international standard for information security management systems (ISMS).
- **Is it possible to deliver the created webcast on other platforms?**
 - Please contact us.



ITmedia Inc.



About Webcast Platform

Introduction of Webcast Platform

Registration page



Viewers must agree to provide personal information when applying.
※Viewers also must set their own password.

Clients can also set up original questions at registration form. (They will be displayed at the end of the form.)

An e-mail will be sent automatically after the registration is completed.



※The client can customize the text of the registration completion e-mail.

The registrants will access the URL in the registration completion email, enter the password that they set themselves and start watching.

Viewing screen image



Webcast Delivery Image (In case of remote delivery/Zoom recording)

Screen Image when using Zoom for remote delivery/recording (assuming 2 lecturers on stage).
*Only 1 speaker will appear in the wipe of the upper right corner.

The screenshot displays a webcast interface. At the top, a message reads: "セミナーは開催されています。再生ボタンをクリックして閲覧を開始してください。" (The seminar is being held. Please click the play button to start viewing.)

The main content area shows a presentation slide with the ITmedia Inc. logo and the text: "Presentation materials shared on screen with the lecturer's PC".

Below the slide, a status bar indicates: "映像が停止したり再生が始まらない場合は、この更新ボタンを押してください。" (If the video stops or does not start playing, please press this update button.) with a red "更新" (Update) button.

At the bottom, a "キャンペーン情報" (Campaign Information) section includes a thumbnail, the date "2021/04/27 22:33 - 2021/04/27 23:33", the title "アイティメディアオンラインセミナー03", and icons for eye and heart with a count of 0.

On the right side, there is a navigation menu with buttons for "アンケート" (Survey), "個別質問" (Individual Question), "チャット" (Chat), "スケジュール" (Schedule), and "お気に入り" (Favorites). Below this is a "Text chat area" with a text input field and a "メッセージをここに書いてください" (Please write your message here) prompt, and a blue send button.

Choice of Delivery Formats

Features of Live streaming

- All sessions will be streamed live non-stop.
- During the lecture, the lecturer can comment on the results of the Poll (simple polling for webcast viewers).
- The lecturer can respond to questions received on the Q&A form during the lecture and stage an interactive seminar.
 - You can also text chat for answer on the delivery platform.

Features of Simu-Live (Pseudo-Live) delivery

- All sessions will be recorded in advance. Because this is separate from the delivery date, it can allow speakers and other interested parties more flexibility in adjusting their schedules.
- Because there is no live streaming operations on the delivery date, it reduces the incidence of problems.
- You can view the result of the Poll, but you cannot comment on it in your session talk.
- Questions received in the Q&A can be answered in text during Simu-Live delivery or you can follow up by email later.

Interactive Communication with Viewers

Can visualize the audience response throughout interactive features

- You can communicate with audiences via one-on-one text chat and group chat.
- Polling function allows you to check the demographics and/or pains of your audience.

Q&A / Chat

Can be communicate in real time with the audiences.
You can reply in the following three patterns

- Read and answer the questions orally.
- Return 1 to 1 chat with text.
- Return 1 to All chat with text.

Q&A/chat reception image

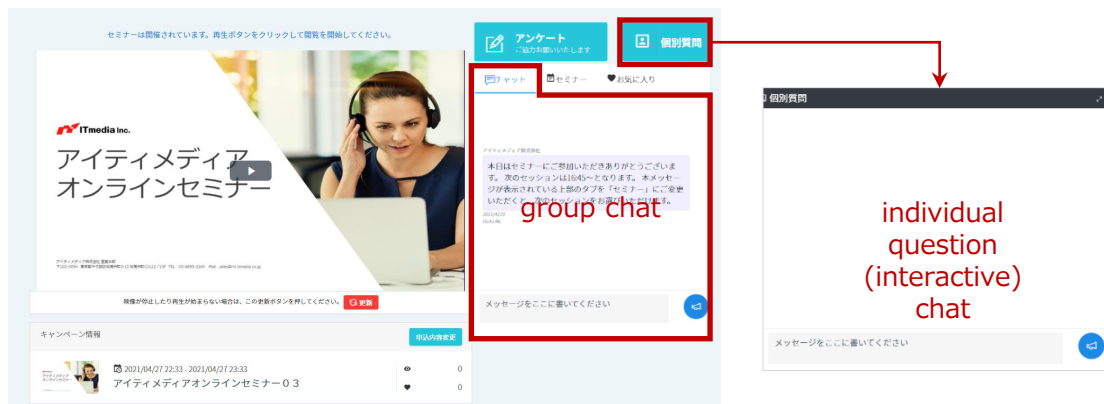

Poll

Polling function that can be displayed as a pop-up on the viewing screen

- The answer is a choice.
- You cannot set a free text answer.
- More than 10 questions and answer items can be configurable.
- Can select whether to show or hide the aggregate results to viewers.



Survey

You can view the survey after the session.

Single-answer, multi-answer, and free-text response formats are available. You can also select required answers.



Features of Online Reporting

Audience information can be viewed in real time through online reports

You can check the registration status, viewing status, viewing time, inflow routes, survey results, etc. on the dashboard.

Seminar administration screen

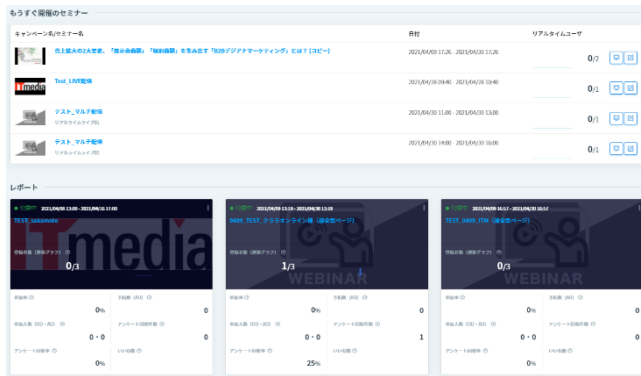

Real Time Report

- Number of real-time users
- Entry/exit status (displayed on a time axis)
- Results of the live voting

Post-event report

- Participation rate
- Number of registrants
- Number of participants
- Number of questionnaires collected
- Survey response rate
- Number of Likes

Dashboard

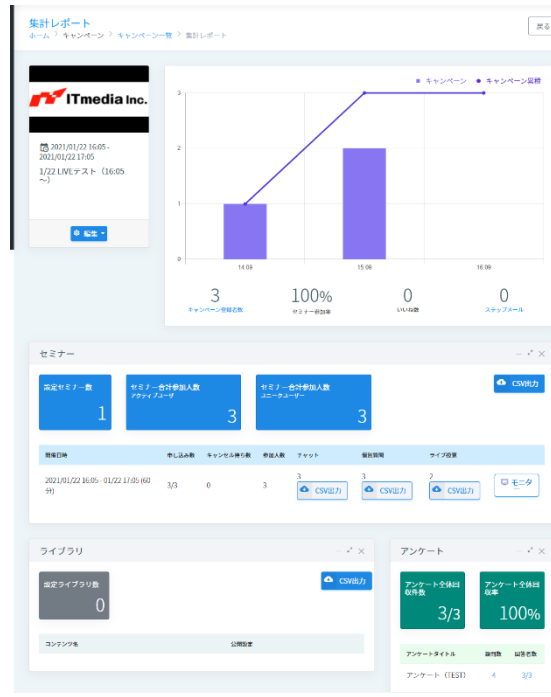

Questionnaire total results

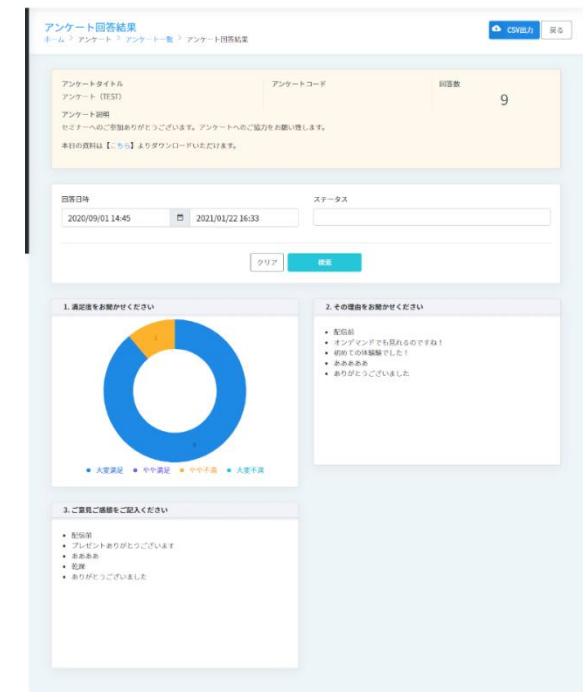

The analysis results can be used to implement the PDCA cycle, improve content, and nurture customers.

Features to Download Detailed Viewing Data

Final data can be downloaded as CSV.

Report screen

① Registrants/Attendees

Log of viewing start time and leaving time (≡ viewing time)*

② Chat log

(A feature which can be viewed by all users + speakers.)

③ Individual questions log

(Q&A, which is invisible to other users.)

④ Live Voting (Poll) Results **

⑤ Content access ***

⑥ Questionnaire response

*Exclusive for Live streaming and Simu-Live delivery.

In the case of On-demand delivery, the first viewed time and the last viewed time can be retrieved.

**Exclusive for Live streaming and Simu-Live delivery.

***Exclusive for On-demand delivery.

セミナー

設定セミナー数 1

セミナー合計参加人数
アクティブユーザー 3

セミナー合計参加人数
ユニークユーザー 3

① CSV出力

開催日時	申し込み数	キャンセル待ち数	参加人数	チャット	個別質問	ライブ投票
2021/01/22 16:05 - 01/22 17:05 (60分)	3/3	0	3	3	3	2

② CSV出力 ③ CSV出力 ④ モニタ

ライブラリ

設定ライブラリ数 0

⑤ CSV出力

アンケート

アンケート全体回答数 3/3

アンケート全体回収率 100%

アンケートタイトル 返回数 回答者数

アンケート (TEST) 4 3/3

アンケート回答結果

ホーム > アンケート > アンケート一覧 > アンケート回答結果

⑥ CSV出力 戻る

アンケートタイトル	アンケートコード	回答数
アンケート (TEST)		9

アンケート説明
セミナーへのご参加ありがとうございます。アンケートへのご協力をお願い致します。
本日の資料は【こちら】よりダウンロードいただけます。

会員情報出力項目選択

- 会員基本プロフィール
 - グループ
 - メールアドレス
 - 氏名
 - 氏名 (カナ)
 - 会社名
 - 郵便番号
 - 都道府県
 - 市区町村
 - 町番地・建物名
 - 部署名
 - 町番地・建物名
 - 部署名
 - 役職
 - お知らせメール
- キャンペーン申込時会員プロフィール
 - 氏名
 - 氏名 (カナ)
 - 会社名
 - 郵便番号
 - 都道府県
 - 市区町村
 - 町番地・建物名
 - 部署名
 - 役職
 - お知らせメール
 - アクセス元URL

閉じる CSV出力

*For CSV export, each profile items can be turned ON or OFF.



ITmedia Inc.



Basic Specifications for Professional Equipment Use

Maximum Equipment Configuration

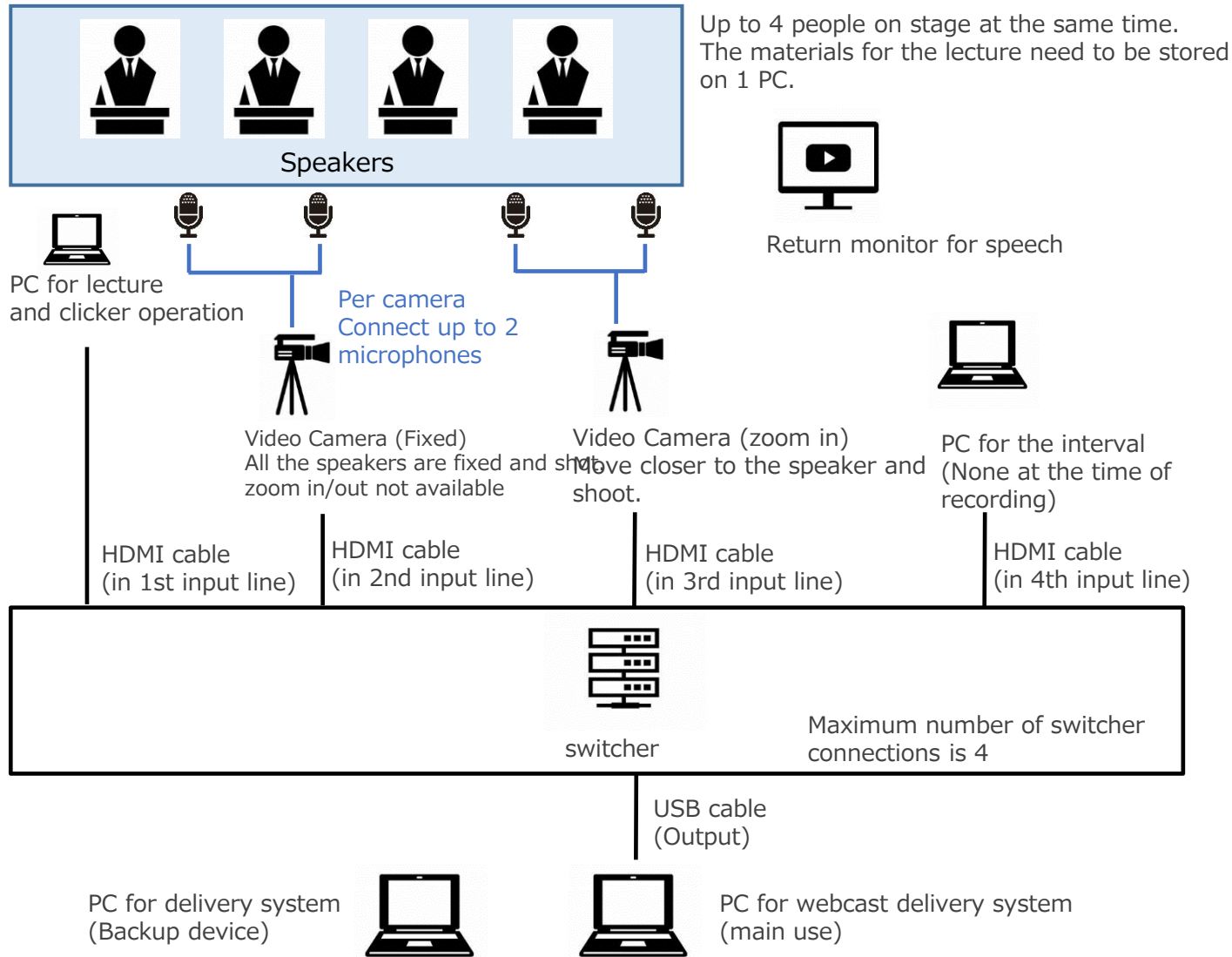

2 delivery staffs



Delivery venue supervision and viewer support

4 video technical staffs



Director, Switcher and Camera persons

Precautions

Additional fees will be charged in the following cases.

- Add microphone
- Add switcher
- Add mixer
- Add camera
- Additional PCs to be connected to the switcher. (for demonstration purposes, etc.)
 - *If you want to do a lecture on your own PC, Windows is recommended.
- Remote conversation between the speaker and the remote person.

※In principle, the number of speakers and equipment configuration should be confirmed at least 1 week prior to the delivery/recording date. Changes made after that date may not be accepted due to equipment availability.

Studios in ITmedia Office

[Room: Tora] Speaker capacity: Recommended 1-2 (Maximum 4)



[Room: Ne/U] Speaker capacity: 3 or more (Splash prevention panels can be set up.)





ITmedia Inc.



Basic Specifications of Full Support Plan

Basic Specifications of Full Support Plan

- Webcast delivery venue is in the ITmedia office
- Use of professional video equipments (camera and switcher)
- Up to 4 speakers at the same time
- 1 track configuration
- No Chromakey (composite background) / No screen caption
- Production of intermission at the start - between sessions - at the end
- Voice Narration with general-purpose scripts (start/end guidance)
- Choose from Live Streaming or Simu-Live (pseudo-Live) Streaming (same price)
- Webcast delivery time of half-day plan is up to 90 minutes
- Live delivery and Simu-Live (pseudo-Live) delivery are both delivered/recorded only once.
- Assigning guest lecturer (1 person), moderating by ITmedia editorial team, guest interviews, etc.

※If you would like to request specifications or direction other than the above, please contact us for a separate estimate. Please ask our sales representative for more details.

Optional Services of Full Support Plan

Content	Price	
Rehearsal on a different day from the live streaming Day/pre-recording day, and additional shooting	1 time	JPY 100,000 or more
Video editing Cut unnecessary parts of the recorded video, adjust audio, etc.	1 session	JPY 50,000 or more
Insertion of video captions During Simu-Live (Pseudo-Live) delivery: Topic title, speaker's name, etc.	1 session	JPY 50,000 or more
Webcast shooting and delivery at studios other than ITmedia office (external studio and equipment fees) In addition to the studio fee (actual cost), a venue adjustment and management fee will be charged.	1 time	Actual cost + Management fee
Assignment of moderator (who do not appear on screen)	1 person	JPY 100,000
Additional registrant fee The maximum number of registered users in the basic plan is 500.	Every additional 250 people	JPY 50,000
Webcast delivery time extension The delivery time in the basic plan is 90 minutes.	Every additional 30 minutes	JPY 30,000
Extend on-demand webcast period	every 1 month	JPY 30,000

Cancellation Policies

If you want to cancel the purchase order for the advertiser's convenience after receiving the purchase order for the advertised product, you will be charged a cancellation fee at the following rate.

Advertising Menu		Cancellation Fee	Applicable Products / Services(Please ask us if you can't find the product in the list below.)	
Display Advertising / Email Advertising		Before the material deadline: 50% After the material deadline: 100%	Display Advertising / Email Advertising	
Advertorial (Tie-in Article)		Before submission of the first draft for proof-reading: 50% of the advertising fee (including production fee, insertion fee and promotion fee) After submission of the first draft for proof-reading: 100% of the advertising fee (including production fee, insertion fee and promotion fee)	Guaranteed Insertion Term Advertorial (Tie-in Article) Guaranteed Page View Advertorial (Tie-in Article)	
Lead Generation	Guaranteed Number of Leads	Lead Generation	Before the campaign starts: 50% of the advertising fee (basic fee + lead generation fee) After the campaign starts: 100% of the advertising fee (basic fee + lead generation fee)	LG. Basic / Segment
		Production Option	Before submission of the first draft for proof-reading: 50% of the production fee After submission of the first draft for proof-reading: 100% of the production fee	LG. Segment Option - Advertorial (Tie-in Article) Production LG. Segment Option - White Paper Production
		Other Options	Before the campaign starts: 50% of the advertising fee (option fee) After the campaign starts: 100% of the advertising fee (option fee)	LG. Segment Option - Customized Survey LG. Segment Option - Telemarketing
	Guaranteed Insertion Term	White Paper	Before the campaign starts: 50% of the advertising fee After the campaign starts: 100% of the advertising fee	TechFactory Guaranteed Insertion Term Program
		Advertorial (Tie-in Article)	Before submission of the first draft for proof-reading: 50% of the advertising fee After submission of the first draft for proof-reading: 100% of the advertising fee	TechFactory Guaranteed Insertion Term Program
	Long Term Lead Generation Program (6 months or more)		Up to the spending of half of the amount applied for: 50% of the advertisement fee(basic fee+lead generation fee) After the spending of half of the amount applied for: Unused portions can be cancelled	LeadGen. Segment (6 months or more Lead Generation Program)
Seminar	Collective Seminar	Until 41days before the seminar opening date: 50% of the advertising fee After 40days before the seminar opening date: 100% of the advertising fee	Seminar Hosted by ITmedia / Virtual Expo Sponsoring Plan	
	Entrusted Seminar	Planning Fee / Operating Fee <ul style="list-style-type: none"> • Until 41 days before the seminar: 50% of the advertising fee • Within 40 days before the seminar: 100% of the advertising fee Other actual cost will be charged in accordance with the cancellation policy of the subcontractor. <ul style="list-style-type: none"> • Venue Fee/ ITmedia's Operating Fee • Any other costs incurred as a result of customizing program 	Entrusted Seminar	
Others	ABM Report	Before the first delivery: 50% of the advertising fee After the first delivery: 100% of the advertising fee	ABM Report	
	Customized Booklet / Offprint	Before submission of the first draft for proof-reading: 50% of the advertising fee After submission of the first draft for proof-reading: 100% of the advertising fee	Custom Booklet Offprint	
	Video Production	Until 2 days before video shooting date: 50% of the advertising fee After the previous day of video shooting date: 100% of the advertising fee	Video Production	
	Customized Research	Before the research starts: 50% of the advertising fee After the research starts: 100% of the advertising fee	Customized Research	



ITmedia Inc.
Sales Division

TEL: 03-6893-2247/2248 Mail: sales@ml.itmedia.co.jp

For member profiles, feature schedules and inquiries, click the URL
below.

<https://promotion.itmedia.co.jp/english>